

LCD-GRAPHIC MODULE

160x128 WITH CONTROLLER T6963

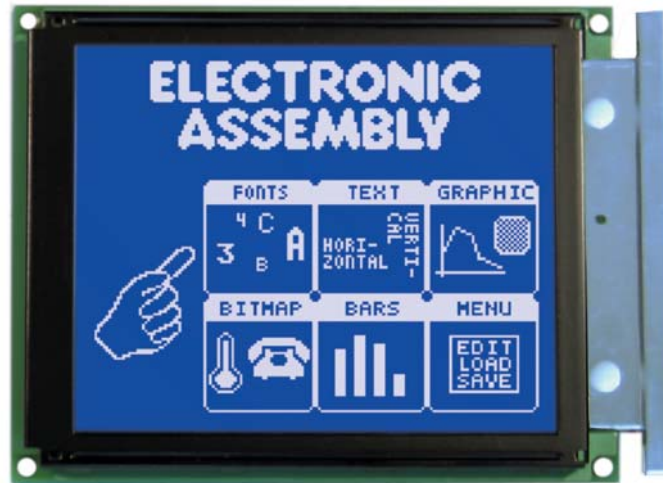

Outline dimensions:
140x102x16mm

FEATURES

- * HIGH CONTRAST STN TECHNOLOGY, NEGATIVE BLUE, BOTTOM VIEW
- * CONTROLLER T6963C BUILT-IN
- * 8-BIT BUS INTERFACE
- * ASCII CHARACTER SET BUILT-IN
- * DISPLAY TEXT AND GRAPHIC SIMULTANEOUSLY
- * ADD SOME SELF-DEFINABLE CHARACTERS
- * POWER SUPPLY +5V (GENERATOR FOR NEGATIVE VOLTAGE BUILT-IN)
- * OPERATING TEMPERATURE -20..+70°C
- * AUTOMATIC TEMPERATURE COMPENSATION CIRCUIT ON-BOARD

ORDERING INFORMATION

GRAPHIC MODULE 160x128 DOTS, T6963C, LED WHITE
 SAME BUT WITH CCFL BACKLIGHT
 WITH TOUCH PANEL, 8x7, LED WHITE
 WITH TOUCH PANEL, 8X7, CCFL BACKLIGHT
 ZIFF CONNECTOR FOR TOUCH PANEL AND DISPLAY
 FFC CABLE FOR DISPLAY, 20-PINS, 110mm
 SOCKET FOR LED BACKLIGHT
 CCFL-INVERTER FOR 5V=

EA W160-7KHLW
 EA W160-7KHC
 EA W160-7KHLWTP
 EA W160-7KHCTP
 EA WF100-20S
 EA KF100-20
 EA G-3KRAG
 EA CXA-E005W

**ELECTRONIC
ASSEMBLY**

making things easy

General

All graphic displays of EA W160-7 series provide high contrast STN technology and high brightness with a resolution of 160x128 dots. You can choose for energy saving white LED backlight or super high bright CCFL backlight.

LED backlight

For this kind of backlight you do need power supply of +5V only. Current consumption will be adjusted by current source or external series resistor. Backlight can be used up to max.150mA (forward voltage is 3.0..3.6V). Please consider for derating at temperatures above 25°C. Please note that because of special low power technology (transmissive type) display may provide a pale contrast at extrem bright conditions like sunlight.

CCFL backlight

For sunlight readable applications we offer same display but with CCFL backlight. Power consumption is typ. 300mA@5V. Operating the backlight requires a CCFL-Inverter (EA CXA-E005W). Life time (MTBF) of CCFL tube is 10,000~20,000 hours. Backlight is available as a spare part with ordering code EA CFL160-7.

built-in Controller T6963 C

All EA W160-7 modules are featured with an on-board controller T 6963C. So display can be connected direct to an 8 bit bus microcontrollersystem. Many comfortable commands are built-in already. Moreover a complete ASCII based character set is built-in that can be expanded with self-defined

characters. Even a complete new character set can be downloaded. Each character can be assigned with an attribute like "invers", "blink" or "invisible".

Graphic mode provides up to 4 pages display RAM (8kB). Text and graphic layer can be combined via "and", "or", "exor" function.

PINout

Connection is done via on-board ZIFF connector (bottom contact type). This requires a FFC cable with 1.0mm pitch and 20 pins like EA KF100-20. Length of cable is 110mm, conductive side is bottom at both ends.

Touch Panel

Optionally these kind of displays are featured with an integrated matrix touch panel. The touch panel allows input operations direct on display screen in a very smart way. Labeling will be done by software, that means it is very flexible to re-label or hide any key.

Pin	Symbol	Function
1	FG	Frame Ground
2	GND	Ground Potential for logic (0V)
3	VDD	Power supply for logic (+5V)
4	VADJ	Contrast adjustment
5	VEE	Operating voltage for LC driving
6	WR	L: Data Write
7	RD	L: Data Read
8	CE	Enable signal (falling edge)
9	C/D	L: Data input H: Command input
10	HALT	L: Oscillator stop
11	RST	L: Reset
12..19	DB0..7	Data Bus Line
20	NC	Do not connect

Specification				
Spezification	min	typ	max	Unit
On resistance	300		10,000	Ω
Voltage	0,5		5	V
Current	10u		10m	A
Key force	150		200	g
Contact bounce		10		ms
Operating temp.	-30		+75	°C
Life time	1,000,000			Cycles

Even different languages can be displayed easily.

Surface of touch panel is scratch-proof and anti-glare to prevent damage and reflexion.

Connection and scan is done in same easy way as for membrane keyboards.



Contrast adjustment

will be done by an external potentiometer. Adjustment will be done once. The built-in temperature compensation circuit provides best contrast for all conditions. Block diagram on page 4 shows a possible application.

Operating the display requires a single supply of +5V only. Internally a negative voltage of about -17V (VEE) is generated for contrast.

Controller T6963C

Command table of built-in controller T6963C is printed below. A detailed description you will find at the *Manual T6963C* (http://www.lcd-module.de/pdf/zubehoer/eng/s_6963.pdf).

Command	Command Code								Description			Remark	
	D7	D6	D5	D4	D3	D2	D1	D0					
Pointer Set	0	0	1	0	0	N2	N1	N0	N2 0 0 1	N1 0 1 0	N0 1 0 0	Cursor pointer set Offset register set Address pointer set	Status Check
Control Word Set	0	1	0	0	0	0	N1	N0		N1 0 0 1 1	N0 0 1 0 1	Text home address set Text area set Graphic home address set Graphic area set	Status Check
Mode Set	1	0	0	0	CG	N2	N1	N0	N2 0 0 0 1	N1 0 0 1 0	N0 0 1 1 0	Graphic and Text; CG=0: ROM, CG=1: RAM OR EXOR AND Text only (attribute capability)	
Display Mode	1	0	0	1	N3	N2	N1	N0				N3=0: Graphic display off N3=1: Graphic display on N2=0: Text display off N2=1: Text display on N1=0: Cursor display off N1=1: Cursor display on N0=0: Cursor blink off N0=1: Cursor blink on	
Cursor Pattern Select	1	0	1	0	0	N2	N1	N0	N2 0 1	N1 0 1	N0 0 1	specifies the number of cursor lines 1 line cursor (bottom line) 8 line cursor (8x8 dot cursor)	
Data Auto Read/Write	1	0	1	1	0	0	N1	N0		N1 0 0 1	N0 0 1 *	Continous data can be written or read Data auto write set Data auto read set Auto reset	
Data Read/Write	1	1	0	0	0	N2	N1	N0				Data read/write command for 1 byte N2=0: Address pointer up/down N2=1: Address pointer unchanged N1=0: Address pointer up N1=1: Address pointer down N0=0: Data write N0=1: Data read	
Screen Peeking	1	1	1	0	0	0	0	0				Transfer display data to data stack for read from CPU	Status Check
Screen Copy	1	1	1	0	1	0	0	0				1 line display data which address is indicated by address pointer is copied to graphic RAM area	Status Check
Bit Set/Reset	1	1	1	1	N3	N2	N1	N0				N3=0: Bit reset N3=1: Bit set N2, N1, N0 indicates the bit in the pointed address (000 is LSB)	Status Check

Table of commands T6963C

with Touch panel

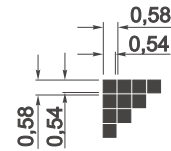
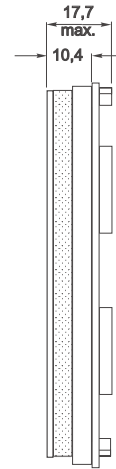
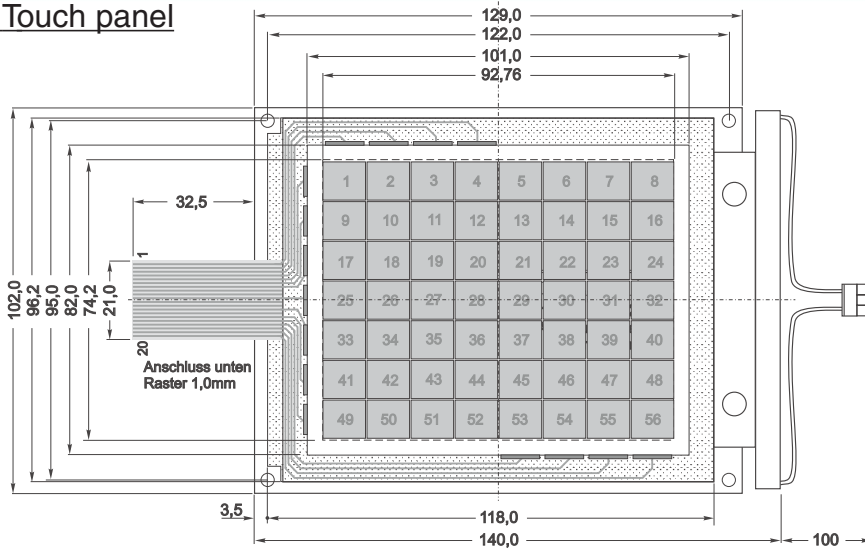

Touchpanel	
Pin	Funktion
1	Spalte 4
2	Spalte 3
3	Spalte 2
4	Spalte 1
5	Zeile 1
6	Zeile 2
7	Zeile 3
8	N.C.
9	N.C.
10	Zeile 4
11	N.C.
12	N.C.
13	N.C.
14	Zeile 5
15	Zeile 6
16	Zeile 7
17	Spalte 5
18	Spalte 6
19	Spalte 7
20	Spalte 8

without Touch panel

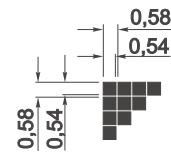
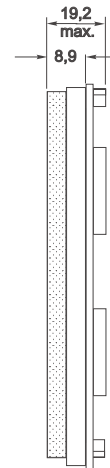
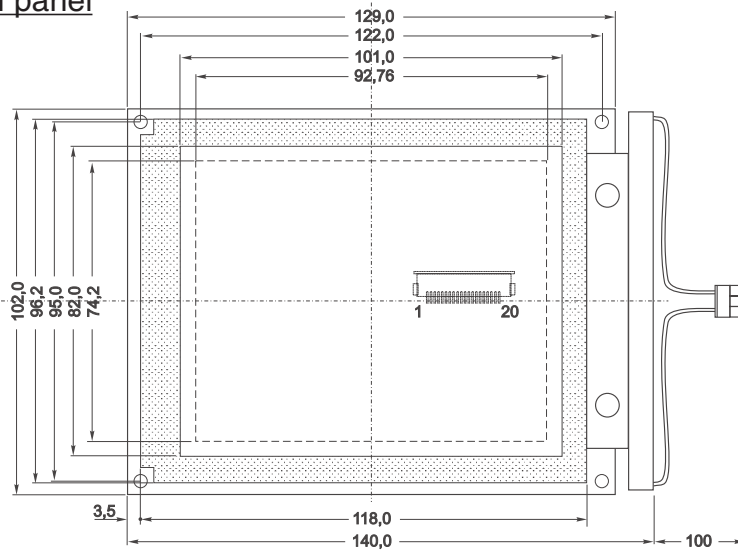

all dimension are in mm

Block diagram

