

LCD MODULE 1x8 - 11.48mm

INCL. CONTROLLER HD 44780

**no more mounting
required**

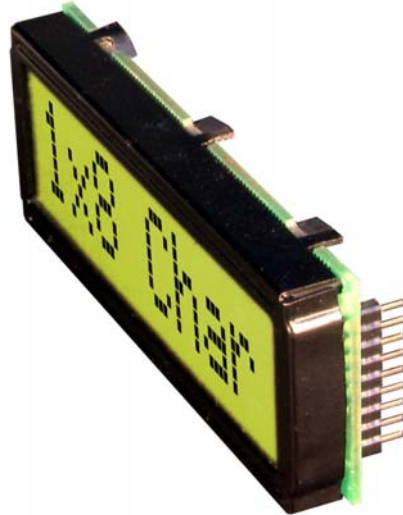

*Dimension 68 x 27 mm
11mm flat even with LED B/L*

FEATURES

- * HIGH CONTRAST LCD SUPERTWIST DISPLAY GRAY OR YELLOW/GREEN
- * COMPATIBLE TO HD 44780 STANDARD
- * INTERFACE FOR 4- AND 8-BIT DATA BUS
- * POWER SUPPLY +2.7~5.5V (BACKLIGHT 4.1V)
- * OPERATING TEMPERATURE RANGE 0~+50°C OR -20~+70°C
- * BUILT-IN TEMP. COMP. WITH EA DIP081-CHNLED
- * LED BACKLIGHT Y/G typ. 150mA@4.1V, max. 200mA
- * SOME MORE MODULES WITH SAME MECHANIC AND SAME PINOUT:
 - DOTMATRIX 2x16, 4x20
 - GRAPHIC 122x32
- * NO SCREWS REQUIRED: SOLDER ON IN PCB ONLY
- * DETACHABLE VIA 9-PIN SOCKET EA B200-9 (2 PCS. REQUIRED)

ORDERING INFORMATION

LCD MODULE 1x8 - 11.48mm WITH BACKLIGHT Y/G
 SAME BUT WITH T_{OP} -20~+70°C, INCL. TEMP.COMP.
 9-PIN SOCKET, HEIGHT 4.3mm (1 PC.)
 SUITABLE BEZEL (WINDOW 60.0x14.8 mm)
 ADAPTOR PCB WITH STANDARD PINOUT PITCH 2.54mm

EA DIP081-CNLED
EA DIP081-CHNLED
EA B200-9
EA 017-2UKE
EA 9907-DIP

**ELECTRONIC
ASSEMBLY** GMBH

LOCHHAMER SCHLAG 17 · D- 82 166 GRÄFELFING
 Phone +49-89-8541991 · FAX +49-89-8541721 · <http://www.lcd-module.de>

EA DIP081-CNLED

PINOUT

Pin	Symbol	Level	Function	Pin	Symbol	Level	Function
1	VSS	L	Power Supply 0V (GND)	10	D3	H/L	Display Data
2	VDD	H	Power Supply +5V	11	D4 (D0)	H/L	Display Data
3	VEE	-	Contrast adjust. (about 0V)	12	D5 (D1)	H/L	Display Data
4	RS	H/L	H=Command, L=Data	13	D6 (D2)	H/L	Display Data
5	RW	H/L	H=Read, L=Write	14	D7 (D3)	H/L	Display Data, MSB
6	E	H	Enable (falling edge)	15	-	-	NC (see EA DIP122-5N)
7	D0	H/L	Display Data, LSB	16	-	-	NC (see EA DIP122-5N)
8	D1	H/L	Display Data	17	A	-	LED B/L+ Resistor required
9	D2	H/L	Display Data	18	C	-	LED B/L -

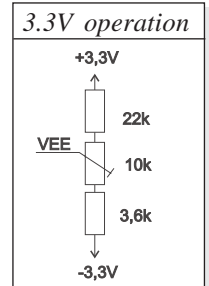
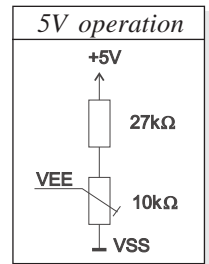

CONTRAST ADJUSTMENT

Both displays EA DIP081-CNLED and -CHNLED do have an driving voltage for contrast of typ. 4,9V. For 3.3V operation additional -3.3V is required.

Version EA DIP081-CHNLED for ext. temperature range -20..+70°C does have a built-in temperature compensation; so there's no need for contrast adjustment while operation.

BACKLIGHT

Backlight do need an external resistor limiting the current limiter. Calculation is: $R=U/I$, so at 5V supply:

$$R_{\text{gelb/grün}} = (5,0V - 4,1V) / 0,15A = 6 \text{ Ohm}$$

Caution: do never drive backlight direct with 5V; damage may come suddenly.

CHARACTER SET

Character set shown below is already built in. In addition to that you are able to define up to 8 characters by yourself.

Lower 4 bit \ Upper 4 bit	0000 (\$0x)	0010 (\$2x)	0011 (\$3x)	0100 (\$4x)	0101 (\$5x)	0110 (\$6x)	0111 (\$7x)	1010 (\$Ax)	1011 (\$Bx)	1100 (\$Cx)	1101 (\$Dx)	1110 (\$Ex)	1111 (\$Fx)
xxxx0000 (\$x0)	CG RAM (0)	0	1	2	3	4	5	6	7	8	9	A	B
xxxx0001 (\$x1)	(1)	!	!	A	Q	a	q	0	7	7	4	ä	q
xxxx0010 (\$x2)	(2)	"	2	B	R	b	r	7	イ	ツ	×	ß	0
xxxx0011 (\$x3)	(3)	#	3	C	S	c	s	7	ウ	7	ε	e	0
xxxx0100 (\$x4)	(4)	\$	4	D	T	d	t	\	I	ト	7	μ	Ω
xxxx0101 (\$x5)	(5)	%	5	E	U	e	u	=	オ	ナ	1	σ	Ü
xxxx0110 (\$x6)	(6)	&	6	F	V	f	v	ヲ	カ	ニ	ヨ	ρ	Σ
xxxx0111 (\$x7)	(7)	'	7	G	W	g	w	ア	キ	ヌ	ウ	g	π
xxxx1000 (\$x8)	CG RAM (0)	(8	H	X	h	x	イ	ウ	ネ	リ	7	Σ
xxxx1001 (\$x9)	(1))	9	I	Y	i	y	ウ	7	7	ル	"	γ
xxxx1010 (\$xA)	(2)	*	:	J	Z	j	z	エ	コ	ン	レ	j	7
xxxx1011 (\$xB)	(3)	+	;	K	[k	[オ	サ	ヒ	0	*	π
xxxx1100 (\$xC)	(4)	,	<	L	¥	l	l	カ	シ	フ	7	φ	π
xxxx1101 (\$xD)	(5)	-	=	M]	m)	ユ	ズ	へ	ン	ε	÷
xxxx1110 (\$xE)	(6)	.	>	N	^	n	→	ヨ	セ	ホ	°	ñ	
xxxx1111 (\$xF)	(7)	/	?	O	_	o	+	ッ	リ	マ	°	ö	■

TABLE OF COMMAND

Instruction	Code										Description	Execute Time (max.)	
	RS	R/W	DB 7	DB 6	DB 5	DB 4	DB 3	DB 2	DB 1	DB 0			
Clear Display	0	0	0	0	0	0	0	0	0	1	Clears all display and returns the cursor to the home position (Address 0).	1.64ms	
Cursor At Home	0	0	0	0	0	0	0	0	0	1 *	Returns the Cursor to the home position (Address 0). Also returns the display being shifted to the original position. DD RAM contents remain unchanged.	1.64ms	
Entry Mode Set	0	0	0	0	0	0	0	1	I/D	S	Sets the Cursor move direction and specifies or not to shift the display. These operation are performed during data write and read.	40µs	
Display On/Off Control	0	0	0	0	0	0	1	D	C	B	Sets ON/OFF of all display (D) cursor ON/OFF (C), and blink of cursor position character (B).	40µs	
Cursor / Display Shift	0	0	0	0	0	1	S/C	R/L	*	*	Moves the Cursor and shifts the display without changing DD RAM contents.	40µs	
Function Set	0	0	0	0	1	DL	N	F	*	*	Sets interface data length (DL) number of display lines (L) and character font (F).	40µs	
CG RAM Address Set	0	0	0	1	ACG							Sets the CG RAM address. CG RAM data is sent and received after this setting.	40µs
DD RAM Address Set	0	0	1	ADD							Sets the DD RAM address. DD RAM data is sent and received after this setting.	40µs	
Busy Flag / Address Read	0	1	BF	AC							Reads Busy flag (BF) indicating internal operation is being performed and reads address counter contents.	-	
CG RAM / DD RAM Data write	1	0	Write Data							Writes data into DD RAM or CG RAM		40µs	
CG RAM / DD RAM Data Read	1	1	Read Data							Reads data from DD RAM or CG RAM		40µs	

INITIALISATION FOR A 1 LINE DISPLAY / 8-BIT MODE

Command	RS	R/W	DB7	DB6	DB5	DB4	DB3	DB2	DB1	DB0	Remark
Function Set	0	0	0	0	1	1	0	0	0	0	8 bit data length, 1 line display, 5x7 font
Display ON/OFF	0	0	0	0	0	0	1	1	1	1	display on, cursor on, cursor blink
Clear Display	0	0	0	0	0	0	0	0	0	1	clear display, cursor 1st. row, 1st. column
Entry Mode Set	0	0	0	0	0	0	0	1	1	0	cursor increments automatically

CREATING YOUR OWN CHARACTERS

All these character display modules got the feature to create 8 own characters (ASCII Codes 0..7) in addition to the 192 ROM fixed codes.

- 1.) The command "CG RAM Address Set" defines the ASCII code (Bit 3,4,5) and the dot line (Bit 0,1,2) of the new character. Example demonstrates creating ASCII code \$00.
- 2.) Doing 8 times the write command "Data Write" defines line by line the new character. 8th. byte stands for the cursor line.
- 3.) The new defined character can be used as a "normal" ASCII code (0..7); use with "DD RAM Address Set" and "Data Write".

Set CG RAM Address				Data										
Adresse		Hex	Bit								Hex			
7	6	5	4	3	2	1	0			Hex				
0	1	0	0	0	0	0	0	0	0	0	0	0	0	\$04
										0	0	0	0	\$04
										0	0	0	0	\$04
										0	0	0	0	\$04
										0	0	0	0	\$04
										1	0	0	0	\$15
										0	1	0	0	\$0E
										0	0	0	0	\$04
0	0	0	0	\$00										

EA DIP081-CNLED

DIMENSIONS

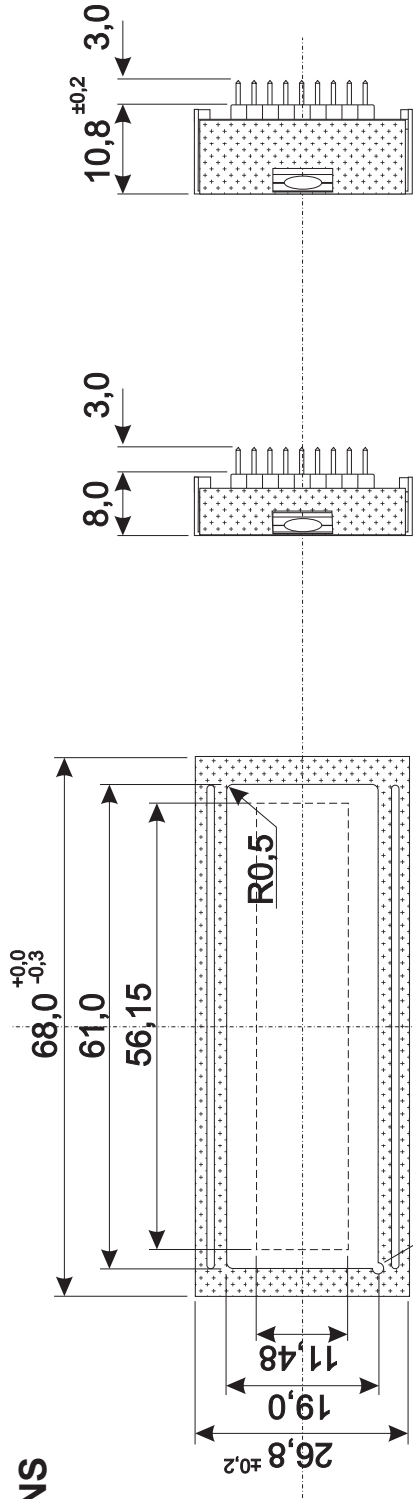

with LED
EA DIP081-CNLED

w/o LED
EA DIP081-CN

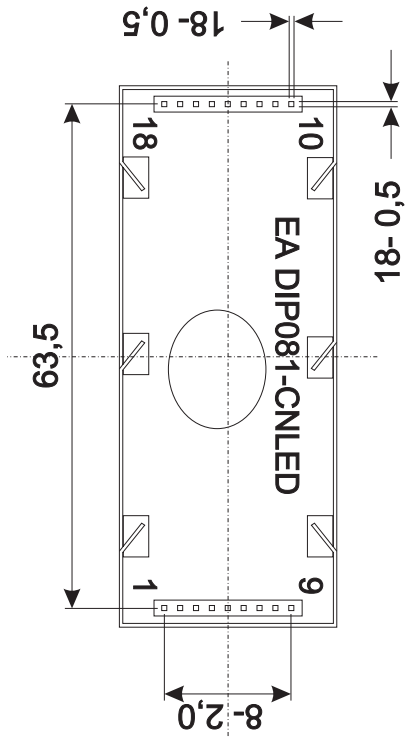
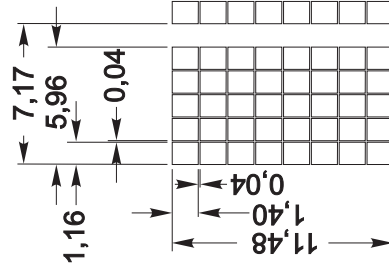

all dimensions are in mm

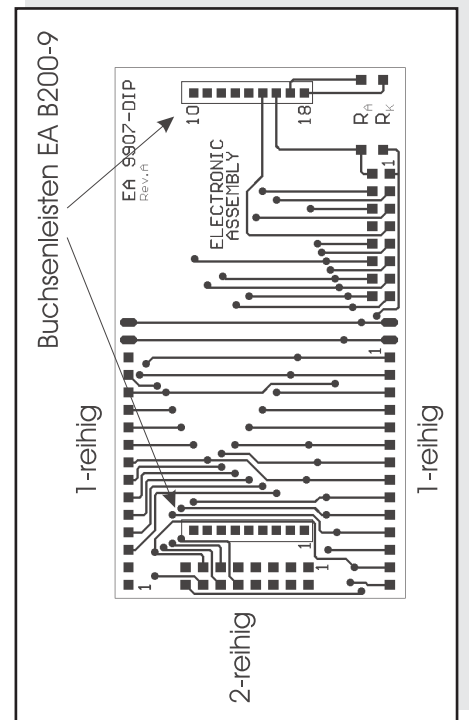

Adaptor pcb
EA 9907-DIP